



HITACHI

L100-M Series Inverter Quick Reference Guide

- Single-phase Input 100V Class



Hitachi Industrial Equipment Systems Co., Ltd.

Manual No. NB5741XD • December 2003



Caution: Be sure to read the L100 Inverter Manual and follow its Cautions and Warnings for the initial product installation. This Quick Reference Guide is intended for reference use by experienced users in servicing existing installations.

Power Circuit Terminals

-002NFE/NFU, -004NFE/NFU, -005NFE

Jumper

(/)	+1	+	-		
L1	L2	N/L3	U/T1	V/T2	W/T3

Chassis Ground

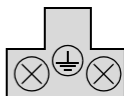

-007 to 022NFE/NFU, -037LFU, 004 to 040HFE/HFU

Jumper

(/)	+1	+	-			
	L1	L2	N/L3	U/T1	V/T2	W/T3

Chassis Ground

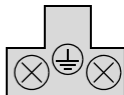

-055LFU, -075LFU, 055HFE/HFU, 075HFE/HFU

Jumper

(/)	+1	+	-		
L1	L2	N/L3	U/T1	V/T2	W/T3

Chassis Ground

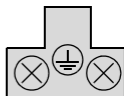

Control Circuit Terminals

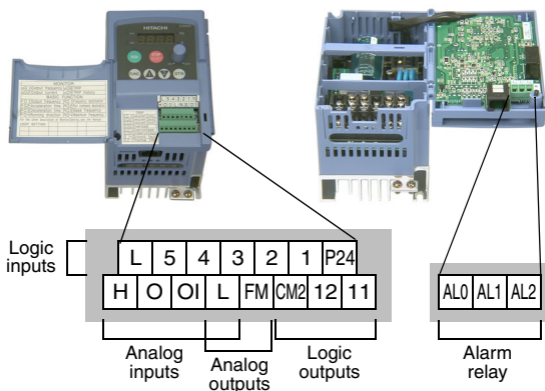

Terminal Name	Description	Ratings and Notes
P24	+24V for logic inputs	24VDC supply, 30 mA max. (Notes: Do not use for network power Do not short to terminal L)
1, 2, 3, 4, 5	Intelligent (programmable) discrete logic inputs	27VDC max. (use P24 or an external supply referenced to terminal L), 4.7k Ω input impedance
11, 12	Discrete logic outputs	50 mA max. ON current, 27 VDC max. OFF voltage
L (top row)	GND for logic inputs	Sum of input 1 to 5 currents (Note: Do not ground)
CM2	Common for logic outputs	100 mA max for sum of terminals 11 and 12 currents
FM	PWM output	0 to 10VDC, 1 mA max., 50% duty cycle
L (bottom row)	Common for analog inputs	Sum of OI, O, and H currents (return)
OI	Analog input, current	4 to 19.6 mA range, 20 mA nominal

Terminal Name	Description	Ratings and Notes
O	Analog input, voltage	0 to 9.6 VDC range, 10VDC nominal, 12VDC max., input impedance 10 k Ω
H	+10V analog reference	10VDC nominal, 10 mA max.
AL0	Relay common contact	Contact rating Max resistive load = 250VAC, 2.5A; 30VDC 3A; Max inductive load = 250VAC, 0.2A; 30VDC 0.7A Minimum load = 5VDC 100mA, 100VAC, 10mA
AL1	Relay contact, normally closed during RUN	
AL2	Relay contact, normally open during RUN	

Basic Wiring Diagram

The following wiring diagram shows the power and motor connections for basic operation. The optional signal input wiring supports external Fwd and Rev Run command, and a speed potentiometer.

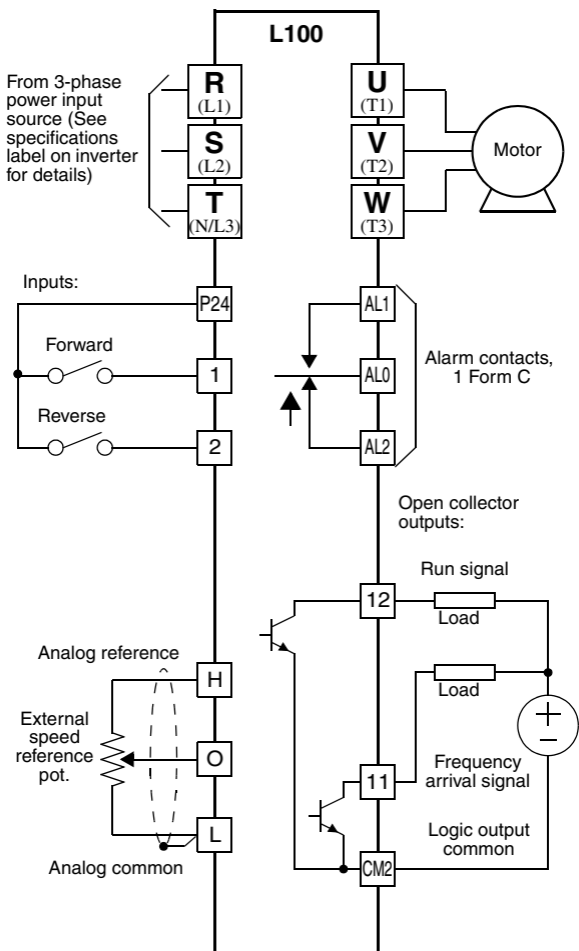

Inverter Keypad Operation

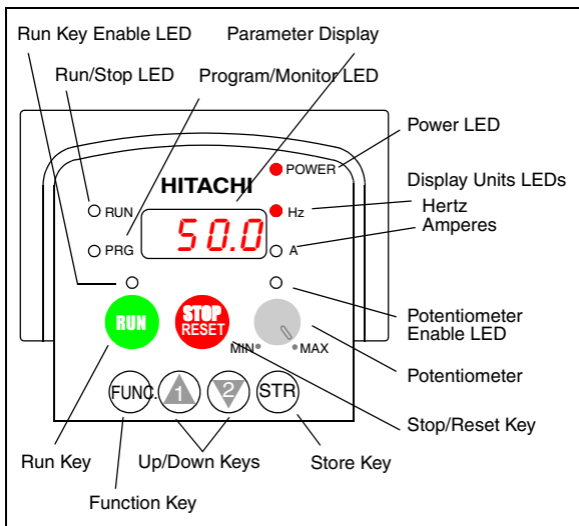

- **Run/Stop LED** – ON when the inverter output is ON and the motor is developing torque, and OFF when the inverter output is OFF (Stop Mode).
- **Program/Monitor LED** – ON when the inverter is ready for parameter editing (Program Mode). It is OFF when the parameter display is monitoring data (Monitor Mode).
- **Run Key Enable LED** – ON when the inverter is ready to respond to the Run key, OFF when the Run key is disabled.
- **Run Key** – Press this key to run the motor (the Run Enable LED must be ON first). Parameter F_04, Keypad Run Key Routing, determines whether the Run key generates a Run FWD or Run REV command.
- **Stop/Reset Key** – Press this key to stop the motor when it is running (uses the programmed deceleration rate). This key will also reset an alarm which has tripped.

(continued, next page...)

- **Potentiometer** – Allows an operator to directly set the motor speed when the potentiometer is enabled for output frequency control.
- **Potentiometer Enable LED** – ON when the potentiometer is enabled for value entry.
- **Parameter Display** – A 4-digit, 7-segment display for parameters and function codes.
- **Display Units: Hertz/Amperes** – One of these LEDs will be ON to indicate the units associated with the parameter display.
- **Power LED** – ON when the power input to the inverter is ON.
- **Function Key** – This key is used to navigate through the lists of parameters and functions for setting and monitoring parameter values.
- **Up/Down Keys** – Use these keys alternately to move up or down the lists of parameter and functions shown in the display, and to increment/decrement values.
- **Store Key** – When the unit is in Program Mode and the operator has edited a parameter value, press the Store key to write the new value to the EEPROM.

Keypad Navigation Map

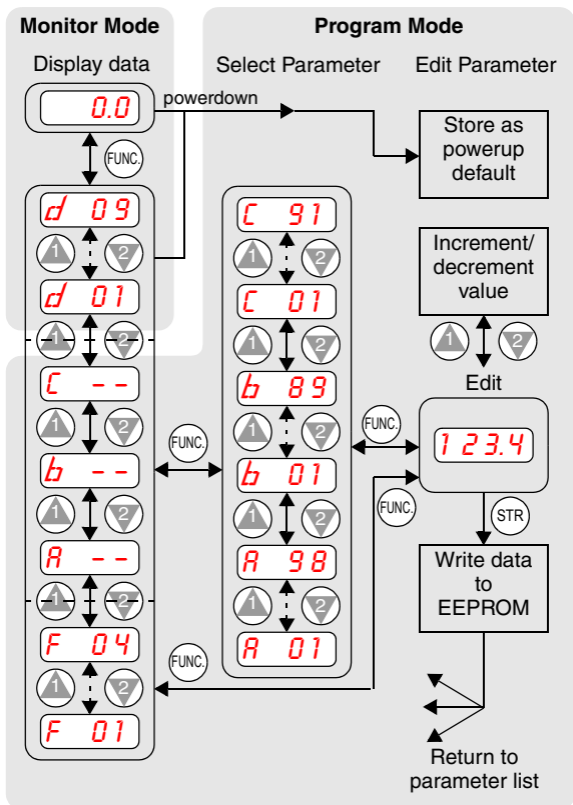

Powerup Test

The Powerup Test procedure uses minimal parameter settings to run the motor. The procedure describes two alternative methods for commanding the inverter: *via the inverter keypad*, or *via the logic terminals*.

- Check power input and motor output wiring (see page 4 diagram).
- If using logic terminals for testing, verify correct wiring on [P24], [FW], [H], [O], and [L] (bottom row) per the diagram on page 4.
- Reverse [RV] input wiring (defaults to terminal [2]) is optional.

Step	Description	Via Keypad	Via Logic Terminals
1	Set speed command source setting	A_01 = 00 (keypad pot.)	A_01 = 01, [H–O–L] input
2	Set Run FW command source	A_02 = 02 (Run key)	A_02 = 01, [FW] input
3	Set Run REV command source	—	C_02 = 01, [RV] input
4	Set motor base freq.	A_03 = 60	
5	Set keypad display to monitor freq.	Access D_01, press Func key, display will show 0.0	
	Perform safety check	Disconnect load from motor	
6		Turn keypad pot. to MIN position	Ensure voltage on [O]—[L] terminals= 0V
7	Run Forward command	Press Run key	Turn ON the [FW] terminal
8	Increase speed	Rotate keypad pot. CW dir.	Increase voltage at [O]
9	Decrease speed	Rotate keypad pot. CCW dir.	Decrease voltage at [O]
10	Stop motor	Press Stop key	Turn OFF the [FW] terminal
11	Run Reverse command (optional)	—	Turn ON the [RV] terminal
12	Stop motor	—	Turn OFF the [RV] terminal

Error Codes

The L100 series inverters will trip on over-current, over-voltage, and under-voltage to protect the inverter. The motor output turns OFF, allowing the motor to free-run to a stop. Press the Stop/Reset key to reset the inverter and clear the error.

Basic Error Codes

Error Code	Name	Probable Cause(s)
<i>E01</i>	Over current event while at constant speed	<ul style="list-style-type: none">• Inverter output was short-circuited• Motor shaft is locked• Load is too heavy• A dual-voltage motor is wired incorrectly Note: The L100 will over current trip at nominally 200% of rated current
<i>E02</i>	Over current event during deceleration	
<i>E03</i>	Over current event during acceleration	
<i>E04</i>	Over current event for other conditions	<ul style="list-style-type: none">• DC braking power(A_54) set too high• Current transformer / noise error
<i>E05</i>	Overload protection	<ul style="list-style-type: none">• Motor overload is detected by the electronic thermal function
<i>E07</i>	Over voltage protection	<ul style="list-style-type: none">• DC bus voltage exceeds a threshold, due to regenerative energy from motor
<i>E08</i>	EEPROM error	<ul style="list-style-type: none">• Built-in EEPROM memory experienced noise, high temperature, etc.
<i>E09</i>	Under-voltage error	<ul style="list-style-type: none">• DC bus voltage decreased enough to cause a control circuit fault
<i>E11</i> <i>E22</i>	CPU error	<ul style="list-style-type: none">• Built-in CPU had internal error
<i>E12</i>	External trip	<ul style="list-style-type: none">• [EXT] input signal detected
<i>E13</i>	USP (Unattended Start Protection)	<ul style="list-style-type: none">• When (USP) was enabled, an error occurred when power was applied while a Run signal was present
<i>E14</i>	Ground fault	<ul style="list-style-type: none">• A ground fault was detected between the inverter output and the motor. This feature protects the inverter, and does not protect humans.
<i>E15</i>	Input over-voltage	<ul style="list-style-type: none">• Input voltage was higher than the specified value, 60 sec. after powerup
<i>E21</i>	Inverter thermal trip	<ul style="list-style-type: none">• Inverter internal temperature is above the threshold



















Error Code	Name	Probable Cause(s)
E35	Thermistor	<ul style="list-style-type: none"> Thermistor input, [THM] and [L], is over the temp. threshold
---	Under-voltage (brown-out) with output shutoff	<ul style="list-style-type: none"> Low input voltage caused the inverter to turn OFF the motor output and try to restart. If unsuccessful, a trip occurs.

Error Trip Conditions

Use function code D_08 to access the error trip conditions for the current error as shown in the table below. Use the Up and Down arrow keys to scroll through the trip condition parameters.

Step	Display
1. Access D_08	d 08
2. Press Function Key	If no error: ---
	If error exists: EXX (error code)
3. Press Up/Dn key (if error exists)	Output frequency at trip point: 10.0 Motor current at trip point: 0.025 DC bus voltage at trip point: 189.8

Restoring Factory Default Settings

Action	Display	Function/Parameter
Press  ,  or  as needed.	b --	“B” Group selected
Press  .	b 01	First “B” Group parameter
Press/hold  until...	b 85	Country code for initialization selected
Press  . If setting is correct, then skip next step.	02	00 = Japan 01 = Europe 02 = United States
To change country code, press  or  to set;  to store.		
Press  .	b 85	Country code for initialization selected
Press  .	b 84	Initialization function selected
Press  .	00	0 = disable initialization, clear trip history only
Press  .	01	1 = enable initialization
Press  .	b 84	Initialization now enabled to restore all defaults
Press/hold  ,  , and  . Do not release yet.	b 84	First part of key sequence
Press/hold  (STOP) for 3 seconds, then release.	d 00	Final part of special sequence, “D_00” is flashing
Now release the all keys together, only after “D_00” display begins blinking.	EU USA JP	Default parameter country code shown during initialization
Initialization is complete.	d 01	Function code for output frequency monitor shown



Note: After initializing the inverter, use the Powerup Test on page 8 to get the motor running again.

Parameter Tables

“D” Group: Monitoring Functions

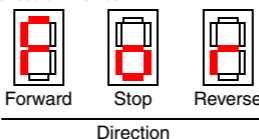
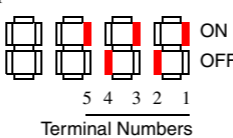
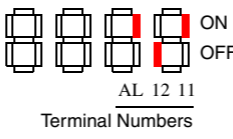
Func. Code	Name / Description	Units
D_01	Output frequency monitor	Hz
D_02	Output current monitor	A
D_03	Rotation direction monitor 	—
D_04	Process variable (PV), PID feedback monitor	%
D_05	Intelligent input terminal status 	—
D_06	Intelligent output terminal status 	—
D_07	Scaled output frequency monitor (output frequency x B_86 scale factor)	User-defined
D_08	Trip event monitor	—
D_09	Trip history monitor	—

Trip History Navigation Map

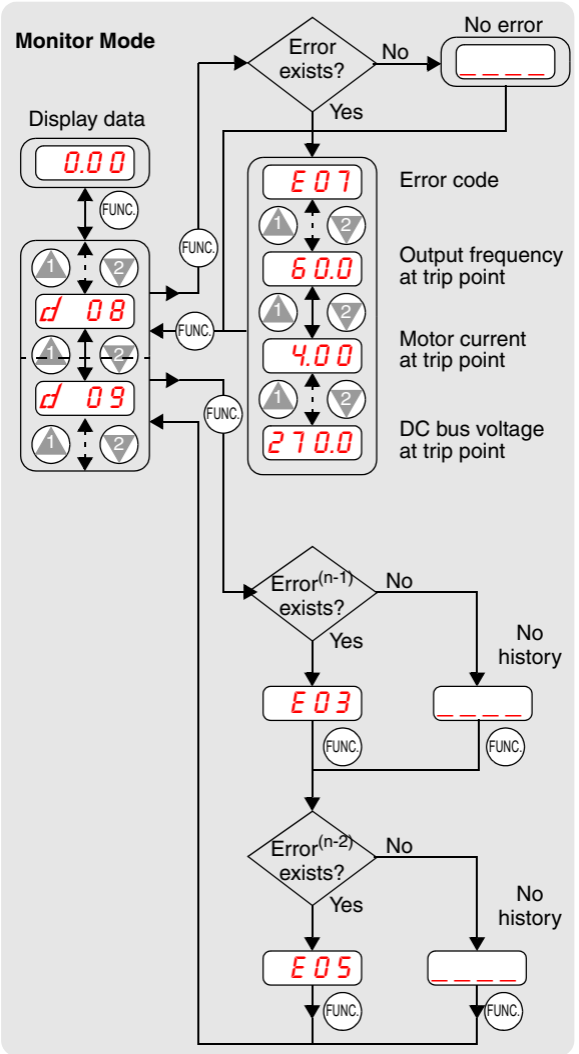

Parameter tables for user-settable functions follow these conventions:

- Some parameters specify an option code. Where applicable, the options codes will be in a bulleted list in the Name/Description column.
- The default values apply to all models unless otherwise noted for each parameter... –FE (Europe) / –FU (U.S.) / –FR (Japan).
- Some parameters cannot be edited during Run Mode, and certain Software Lock settings (B_31) can prohibit all edits. If in doubt, place the inverter in Stop Mode or consult the inverter manual for details.

“F” Group: Main Profile Parameters

Func. Code	Name / Description	Default Value	Set Value
F_01	Output frequency setting	0.0	
F_02	Acceleration (1) time setting	10.0	
F_03	Deceleration (1) time setting	10.0	
F_04	Keypad Run key routing • 00 Forward • 01 Reverse	00	

“A” Group: Standard Functions

Func. Code	Name / Description	Default Value -FE / -FU / -FR	Set Value
A_01	Frequency source setting • 00 Keypad potentiometer • 01 Control terminal • 02 Function F_01 setting	01 / 01 / 00	
A_02	Run command source setting • 01 Input terminal FW or RV (assignable) • 02 Run key on keypad, or digital operator	01 / 01 / 02	
A_03	Base frequency setting	50.0 / 60.0 / 60.0	
A_04	Maximum frequency setting	50.0 / 60.0 / 60.0	
A_11	O/OI-L input active range start frequency	0.0	
A_12	O/OI-L input active range end frequency	0.0	
A_13	O/OI-L input active range start voltage	0	
A_14	O/OI-L input active range end voltage	100	
A_15	O/OI-L input start frequency enable • 00 Use A_11 starting value) • 01 Use 0 Hz	01	
A_16	External frequency filter time constant	8	
A_20	Multi-speed frequency setting	0	
A_21 A_22 A_23 A_24 A_25 A_26 A_27 A_28 A_29.. ..A_35	Multi-speed frequency settings	0 / 0 / 5 0 / 0 / 10 0 / 0 / 15 0 / 0 / 20 0 / 0 / 30 0 / 0 / 40 0 / 0 / 50 0 / 0 / 60 0 / 0 / 0	
A_38	Jog frequency setting	1.0	
A_39	Jog stop mode • 00 Free-run stop, jogging disabled during motor run • 01 Controlled deceleration, jogging disabled during motor run • 02 DC braking to stop, jogging disabled during motor run	00	

Func. Code	Name / Description	Default Value -FE / -FU / -FR	Set Value
A_41	Torque boost method selection • 00 Manual torque boost • 01 Automatic torque boost	00	
A_42	Manual torque boost value	11	
A_43	Manual torque boost frequency adjustment	10.0	
A_44	V/f characteristic curve selection • 00 V/f constant torque • 01 V/f variable torque	00	
A_45	V/f gain setting	100	
A_51	DC braking enable • 00 Disable • 01 Enable	00	
A_52	DC braking frequency setting	0.5	
A_53	DC braking wait time	0.0	
A_54	DC braking force during deceleration	0	
A_55	DC braking time for deceleration	0.0	
A_61	Frequency upper limit setting	0.0	
A_62	Frequency lower limit setting	0.0	
A_63 A_65 A_67	Jump (center) frequency setting	0.0	
A_64 A_66 A_68	Jump (hysteresis) frequency width setting	0.5	
A_71	PID Enable • 00 PID operation OFF • 01 PID operation ON	00	
A_72	PID proportional gain	1.0	
A_73	PID integral time constant	1.0	
A_74	PID derivative time constant	0.0	
A_75	PV scale conversion	1.00	
A_76	PV source setting • 00 [OI] terminal (current input) • 01 [O] terminal (voltage input)	00	
A_81	AVR function select • 00 AVR enabled • 01 AVR disabled • 02 AVR enabled except during decel	02 / 00 / 02	

Func. Code	Name / Description	Default Value -FE / -FU / -FR	Set Value
A_82	AVR voltage select	230/230/200 400/460/400	
A_92	Acceleration (2) time setting	15.0	
A_93	Deceleration (2) time setting	15.0	
A_94	Select method to switch to Acc2/Dec2 profile • 00 2CH input from terminal • 01 transition frequency	00	
A_95	Acc1 to Acc2 frequency transition point	0.0	
A_96	Dec1 to Dec2 frequency transition point	0.0	
A_97	Acceleration curve selection • 00 Linear • 01 S-curve	00	
A_98	Deceleration curve selection • 00 Linear • 01 S-curve	00	

“B” Group: Fine-tuning Functions

Func. Code	Name / Description	Default Value -FE / -FU / -FR	Set Value
B_01	Selection of automatic restart mode • 00 Alarm output after trip, automatic restart disabled • 01 Restart at 0Hz • 02 Resume operation after frequency matching • 03 Resume previous freq. after freq. matching, then decelerate to stop and display trip info	00	
B_02	Allowable under-voltage power failure time	1.0	
B_03	Retry wait time before motor restart	1.0	

Func. Code	Name / Description	Default Value -FE / -FU / -FR	Set Value
B_12	Level of electronic thermal setting	Rated current of each inverter	
B_13	Electronic thermal characteristic • 00 Reduced torque • 01 Const. torque	01 / 01 / 00	
B_21	Overload restriction operation mode • 00 Disabled • 01 Enabled for accel and constant speed • 02 Enabled for constant speed only	01	
B_22	Overload restriction setting	Rated current x 1.25	
B_23	Deceleration rate at overload restriction	1.0	
B_31	Software lock mode selection • 00 Low-level access, [SFT] blocks edits • 01 Low-level access, [SFT] blocks edits (except F_01 and Multi-speed parameters) • 02 No access to edits • 03 No access to edits except F_01 and Multi-speed parameters	01	
B_32	Reactive current setting Note: For Japanese (-FR) versions, only -055LFR, -055HFR, -075LFR, and -075HFR models support this function.	58% rated current	
B_81	[FM] terminal analog meter adjustment	80	
B_82	Start frequency adjustment	0.5	
B_83	Carrier frequency setting	5.0 / 5.0 / 12.0	
B_84	Initialization mode (parameters or trip history) • 00 Trip history clear • 01 Parameter initialization	00	
B_85	Country code for initialization • 00 Japan version • 01 Europe version • 02 US version	01 / 02 / 00	
B_86	Frequency scaling conversion factor	1.0	
B_87	STOP key enable • 00 Enable • 01 Disable	00	

Func. Code	Name / Description	Default Value -FE / -FU / -FR	Set Value
B_88	Restart mode after FRS <ul style="list-style-type: none"> • 00 Restart from 0Hz • 01 Restart from frequency detected from actual speed of motor 	00	
B_89	Data select for digital operator OPE-J <ul style="list-style-type: none"> • 01 Output frequency (D_01) • 02 Output current (D_02) • 03 Motor direction (D_03) • 04 PID PV feedback (D_04) • 05 Input states for input terminals (D_05) • 06 Output states for output terminals (D_06) • 07 Scaled output frequency (D_07) 	01	

“C” Group: Intelligent Terminal Functions

Func. Code	Name / Description		Default Value -FE / -FU / -FR	Set Value
C_01	Terminal [1] function	Fifteen option codes available (see page 21)	00	
C_02	Terminal [2] function		01	
C_03	Terminal [3] function		02 / 16 / 02	
C_04	Terminal [4] function		03 / 13 / 03	
C_05	Terminal [5] function		18	
C_11	Terminal [1] active state	<ul style="list-style-type: none"> • 00 Normally open [NO] • 01 Normally closed [NC] 	00	
C_12	Terminal [2] active state		00	
C_13	Terminal [3] active state		00	
C_14	Terminal [4] active state		00 / 01 / 00	
C_15	Terminal [5] active state		00	

Func. Code	Name / Description		Default Value -FE / -FU / -FR	Set Value
C_21	Terminal [11] function	Six option codes available (see page 22)	01	
C_22	Terminal [12] function		00	
C_23	[FM] signal selection	Three option codes available (see page 22)	00	
C_31	Terminal [11] active state (-FU)	<ul style="list-style-type: none"> • 00 Normally open (NO) • 01 Normally closed (NC) 	— / 00 / —	
	Reserved (-FE / -FR)		00 / — / 00	
C_32	Terminal [12] active state (-FU)		— / 00 / —	
	Terminal [11] active state (-FE / -FR)		00 / — / 00	
C_33	Alarm relay terminal active state		01	
C_41	Overload level setting		Rated current of each inverter	
C_42	Frequency arrival setting for accel		0.0	
C_43	Arrival frequency setting for decel		0.0	
C_44	PID deviation level setting		3.0	
C_91	Debug mode enable <ul style="list-style-type: none"> • 00 Display • 01 No display 		00	

Intelligent Input Terminal Listing

Symbol	Code	Input Terminal Name
FWD	00	Forward Run/Stop
RV	01	Reverse Run/Stop
CF1	02	Multi-speed select, Bit 0 (LSB)
CF2	03	Multi-speed select, Bit 1
CF3	04	Multi-speed select, Bit 2
CF4	05	Multi-speed select, Bit 3 (LSB)
JG	06	Jogging
2CH	09	2-stage accel and decel
FRS	11	Free-run stop
EXT	12	External trip
USP	13	Unattended start protection
SFT	15	Software lock
AT	16	Analog input voltage/current sel.
RS	18	Reset inverter
PTC	19	PTC thermistor thermal protection

Intelligent Output Terminal Listing

Symbol	Code	Input Terminal Name
RUN	00	Run signal
FA1	01	Freq. arrival type 1 – constant speed
FA2	02	Freq. arrival type 2 – over-frequency
OL	03	Overload advance notice signal
OD	04	Output deviation for PID control
AL	05	Alarm signal

Analog Input Configuration

The following tables show the parameter settings required for various analog input signal types.

[AT]	External Frequency Command Input
OFF	[O] — [L]
ON	[OI] — [L]
(not assigned to any input terminal)	Summation of [O] — [L] and [OI] — [L]

Analog Output Function Listing

The following table shows all three functions available for assignment to the analog output terminal:

- Terminal [FM], option set by C_23

Option Code	Function Name	Description	Corresponding Signal Range
00	Output frequency	Actual motor speed, represented by PWM signal	0 to max. freq. in Hz
01	Output current	Motor current (% of maximum rated output current), represented by PWM signal	0 to 200%
02	Digital output frequency	Output frequency	0 to max. freq. in Hz

Notes: