

L300P Series Inverter Quick Reference Guide

- Three-phase Input 200V Class
- Three-phase Input 400V Class

UL Version Models



CE Version Models



Hitachi Industrial Equipment Systems Co., Ltd.

Manual No. NB6041XF • September 2006



Caution: Be sure to read the L300P Inverter Manual and follow its Cautions and Warnings for the initial product installation. This Quick Reference Guide is intended for reference use by experienced users in servicing existing installations.

UL[®] Cautions, Warnings, and Instructions

Wiring Warnings for Electrical Practices and Wire Sizes

The Cautions, Warnings, and instructions in this section summarize the procedures necessary to ensure an inverter installation complies with Underwriters Laboratories[®] guidelines.



Warning: “Use 60/75°C Cu wire only” or equivalent.

Warning: “Open Type Equipment.” For models L300P–900H to L300P–1320H.

Warning: “Suitable for use on a circuit capable of delivering not more than 100,000 rms symmetrical amperes, 240 V maximum.” For models with suffix L.

Warning: “Suitable for use on a circuit capable of delivering not more than 100,000 rms symmetrical amperes, 480 V maximum.” For models with suffix H.

Terminal Tightening Torque and Wire Size

The wire size range and tightening torque for field wiring terminals are presented in the tables below.

200V Models					
Motor output		Inverter Model	Wire Size (AWG)	Torque	
kW	HP			ft-lbs	(N-m)
1.5	2	–015LFU2	14	1.1	1.5
2.2	3	–022LFU2	14	1.1	1.5
3.7	5	–037LFU2	10	1.1	1.5
5.5	7 1/2	–055LFU2	8	1.8	2.5
7.5	10	–075LFU2	6	1.8	2.5
11	15	–110LFU2	4	3.6	4.9
15	20	–150LFU2	2	3.6	4.9
18.5	25	–185LFU2	1	3.6	4.9
22	30	–220LFU2	1/0	6.5	8.8

200V Models					
Motor output		Inverter Model	Wire Size (AWG)	Torque	
kW	HP			ft-lbs	(N-m)
30	40	-300LFU2	1/0	6.5	8.8
37	50	-370LFU2	1/0 1/0 AWG	6.5	8.8
45	60	-450LFU2	1/0 1/0 AWG	10.1	13.7
55	75	-550LFU2	2/0 2/0 AWG	10.1	13.7
75	100	-750LFU2	3/0 3/0 AWG	10.1	13.7

400V Models					
Motor output		Inverter Model	Wire Size (AWG)	Torque	
kW	HP			ft-lbs	(N-m)
1.5	2	-015HFU2/E2	20	1.1	1.5
2.2	3	-022HFU2/E2	18	1.1	1.5
4.0	5	-037HFU2/E2	16	1.1	1.5
5.5	7 1/2	-055HFU2/E2	14	1.1	1.5
7.5	10	-075HFU2/E2	12	1.8	2.5
11	15	-110HFU2/E2	8	3.6	4.9
15	20	-150HFU2/E2	6	3.6	4.9
18.5	25	-185HFU2/E2	6	3.6	4.9
22	30	-220HFU2/E2	4	3.6	4.9
30	40	-300HFU2/E2	3	3.6	4.9
37	50	-370HFU2/E2	1	3.6	4.9
45	60	-450HFU2/E2	1	6.5	8.8
55	75	-550HFU2/E2	1/0 AWG	6.5	8.8
75	100	-750HFU2/E2	1/0 1/0 AWG	6.5	8.8
90	125	-900HFU2/E2	3/0 (1/0 1/0 AWG)	10.1	13.7
110	150	-1100HFU2/E2	2/0 2/0 AWG	10.1	13.7
132	175	-1320HFU2/E2	2/0 2/0 AWG	10.1	13.7

Wire Connectors



Warning: Field wiring connections must be made by a UL Listed and CSA Certified ring lug terminal connector sized for the wire gauge being used. The connector must be fixed using the crimping tool specified by the connector manufacturer.

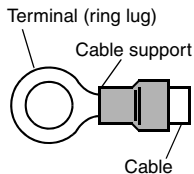

Fuse and Circuit Breaker Sizes

The inverter's input power wiring must include UL Listed, dual-element, 600V fuses, or UL Listed, inverse-time, 600V circuit breakers.

200V Models			
Motor output		Inverter Model	Ampere Rating for Fuse or Breaker
kW	HP		
1.5	2	-015LFU2	10
2.2	3	-022LFU2	15
3.7	5	-037LFU2	20
5.5	7 1/2	-055LFU2	30
7.5	10	-075LFU2	40
11	15	-110LFU2	60
15	20	-150LFU2	70
18.5	25	-185LFU2	90
22	30	-220LFU2	100
30	40	-300LFU2	150
37	50	-370LFU2	175
45	60	-450LFU2	200
55	75	-550LFU2	250
75	100	-750LFU2	300

400V Models			
Motor output		Inverter Model	Ampere Rating for Fuse or Breaker
kW	HP		
1.5	2	-015HFU2/E2	10
2.2	3	-022HFU2/E2	10
4.0	5	-037HFU2/E2	15
5.5	7 1/2	-055HFU2/E2	15
7.5	10	-075HFU2/E2	20
11	15	-110HFU2/E2	30
15	20	-150HFU2/E2	35
18.5	25	-185HFU2/E2	50
22	30	-220HFU2/E2	50
30	40	-300HFU2/E2	70
37	50	-370HFU2/E2	80
45	60	-450HFU2/E2	100
55	75	-550HFU2/E2	125
75	100	-750HFU2/E2	150
90	125	-900HFU2/E2	200
110	150	-1100HFU2/E2	225
132	175	-1320HFU2/E2	300

Motor Overload Protection

Hitachi L300P inverters provide solid state motor overload protection, which depends on the proper setting of the following parameters:

- B012 “electronic overload protection”
- B212 “electronic overload protection, 2nd motor”

Set the rated current [Amperes] of the motor(s) with the above parameters. The setting range is 0.2 * rated current to 1.2 * rated current.



Warning: When two or more motors are connected to the inverter, they cannot be protected by the electronic overload protection. Install an external thermal relay on each motor.

Power Circuit Terminals

Inverter models:

-015 to -055LFU2

-015 to -055HFU2, HFE2

R₀ (R0)	T₀ (T0)	R (L1)	S (L2)	T (L3)	U (T1)	V (T2)	W (T3)
		PD (+1)	P (+)	N (-)	RB (RB)	\perp (G)	\perp (G)

Jumper 

Inverter models:

-075LFU2

-075HFU2, HFE2

-110LFU2

-110HFU2, HFE2

-150LFU2

-150HFU2, HFE2

R (L1)	S (L2)	T (L3)	U (T1)	V (T2)	W (T3)	R₀ (R0)	T₀ (T0)
PD (+1)	P (+)	N (-)	RB (RB)	\perp (G)	\perp (G)		

Jumper 

Inverter models:

-185LFU2

-185 to -370HFU2, HFE2

-370LFU2,

-450 to -750HFU2, HFE2

R₀ (R0)	T₀ (T0)
------------------------------	------------------------------

\perp (G)	R (L1)	S (L2)	T (L3)	PD (+1)	P (+)	N (-)	U (T1)	V (T2)	W (T3)	\perp (G)
----------------	------------------	------------------	------------------	-------------------	-----------------	-----------------	------------------	------------------	------------------	----------------

Jumper 

Inverter models:

-220LFU2, -300LFU2,

-450 to -750LFU2,

-900 to -1320HFU2, HFE2

R₀ (R0)	T₀ (T0)
------------------------------	------------------------------

R (L1)	S (L2)	T (L3)	PD (+1)	P (+)	N (-)	U (T1)	V (T2)	W (T3)
------------------	------------------	------------------	-------------------	-----------------	-----------------	------------------	------------------	------------------

\perp
(G)

Jumper 

\perp
(G)

Control Circuit Terminals

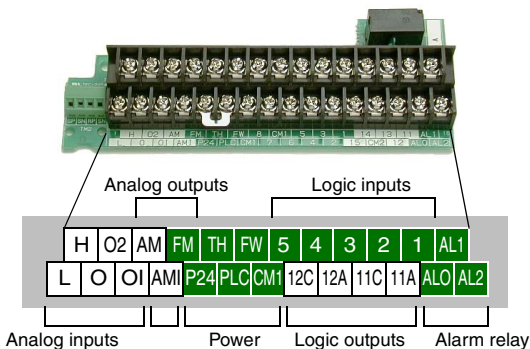

Terminal Name	Description	Ratings and Notes
P24	+24V power for inputs	24VDC supply, 100 mA max.
CM1	+24V common	Common for 24V supply, FW, TH, inputs 1 to 5, and FM. (Note: Do not ground)
PLC	Common for logic inputs	Common for input terminals 1 to 5, jumper to CM1 for sinking, jumper to P24 for sourcing
1, 2, 3, 4, 5	Intelligent (programmable) discrete logic inputs	27VDC max. (use P24 or an external supply referenced to terminal CM1), 4.7k Ω input impedance
FW	Forward/stop command	27VDC max. (use P24 or an external supply referenced to terminal CM1), 4.7k Ω input impedance
11C—11A 12C—12A	Intelligent (programmable) relay outputs	Normally open contacts 250VAC / 30VDC, 5A (resistive load) max., 250VAC / 30VDC, 5A (inductive load) max. Minimum load 5VDC, 5mA
TH	Thermistor input	Reference to CM1, min. thermistor power 100mW
FM	PWM output	0 to 10VDC, 1.2 mA max., 50% duty cycle

Terminal Name	Description	Ratings and Notes
AM	Voltage analog output	0 to 10VDC, 2 mA max.
AMI	Current analog output	4-20 mA, nominal load impedance 250Ω
L	Common for analog inputs	Sum of OI, O, and H currents (return)
OI	Analog input, current	4 to 19.6 mA range, 20 mA nominal
O	Analog input, voltage	0 to 9.6 VDC range, 10VDC nominal, 12VDC max., input impedance 10 kΩ
H	+10V analog reference	10VDC nominal, 10 mA max.
AL0	Relay common contact	Contacts AL0–AL1, max resistive load = 250VAC 2A; 30VDC 8A; max inductive 250VAC, 0.2A; 30VDC 0.6A Contacts AL0–AL2, max resistive load = 250VAC 1A; 30VDC 1A; max inductive = 250VAC, 0.2A; 30VDC 0.2A Both contact pairs, min. loads = 100VAC 10mA; 5VDC 100mA
AL1	Relay contact, normally closed during RUN	
AL2	Relay contact, normally open during RUN	

Serial Port Terminals

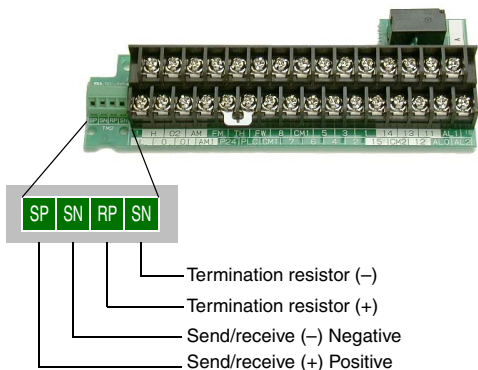

Basic Wiring Diagram

The following wiring diagram shows the power and motor connections for basic operation. The optional signal input wiring supports external Fwd and Rev Run command, and a speed potentiometer.

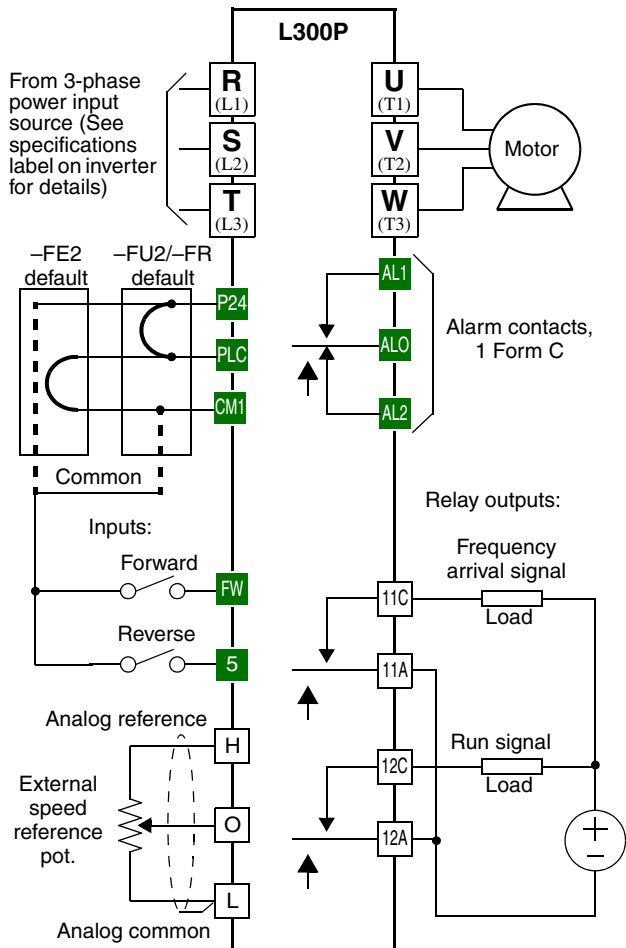

Inverter Keypad Operation

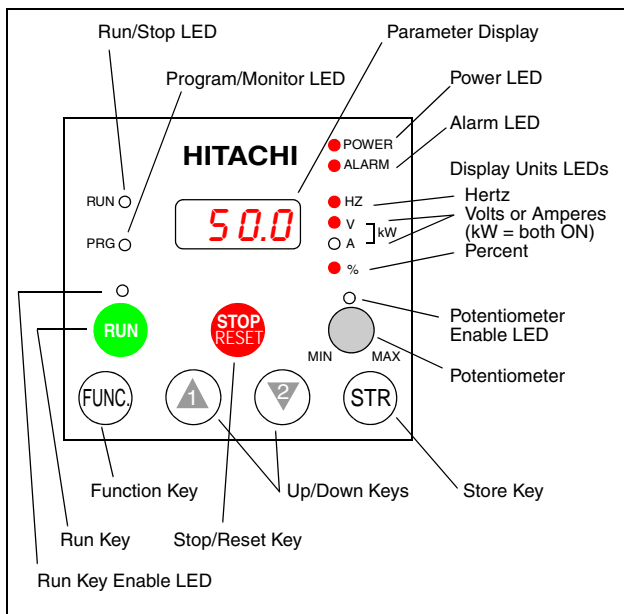

- **Run/Stop LED** – ON when the inverter output is ON and the motor is developing torque, and OFF when the inverter output is OFF (Stop Mode).
- **Program/Monitor LED** – This LED is ON when the inverter is ready for parameter editing (Program Mode). It is normally OFF when the parameter display is monitoring data (Monitor Mode). However, the PRG LED will be ON whenever you are monitoring the value of parameter D001. (When the keypad is enabled as the frequency source via A001=02, you can edit the inverter frequency directly from D001 monitor display by using the Up/Down keys.)
- **Run Key Enable LED** – ON when the inverter is ready to respond to the Run key, OFF when the Run key is disabled.
- **Run Key** – Press this key to run the motor (the Run Enable LED must be ON first). Parameter F004, Keypad Run Key Routing, determines whether the Run key generates a Run FWD or Run REV command.

(continued, next page...)

- **Stop/Reset Key** – Press this key to stop the motor when it is running (uses the programmed deceleration rate). This key will also reset an alarm which has tripped.
- **Potentiometer** – Allows an operator to directly set the motor speed when the potentiometer is enabled for output frequency control.
- **Potentiometer Enable LED** – ON when the potentiometer is enabled for value entry.
- **Parameter Display** – A 4-digit, 7-segment display for parameters and function codes.
- **Display Units: Hertz/Volts/Amperes/kW/%** – These LEDs indicate the units associated with the parameter display. When the display is monitoring a parameter, the appropriate LED is ON. In the case of kW units, both Volts and Amperes LEDs will be ON. An easy way to remember this is that $kW = (V \times A)/1000$.
- **Power LED** – ON when the power input to the inverter is ON.
- **Alarm LED** – ON when an alarm condition has tripped the inverter. Clearing the alarm will turn this LED OFF again. See page 13 for details on clearing alarms.
- **Function Key** – This key is used to navigate through the lists of parameters and functions for setting and monitoring parameter values.
- **Up/Down Keys** – Use these keys alternately to move up or down the lists of parameter and functions shown in the display, and to increment/decrement values.
- **Store Key** – When the unit is in Program Mode and the operator has edited a parameter value, press the Store key to write the new value to the EEPROM. This parameter is then displayed at powerup by default. If you want to change the powerup default, navigate to a new parameter value and press the Store key.

Keypad Navigation Map

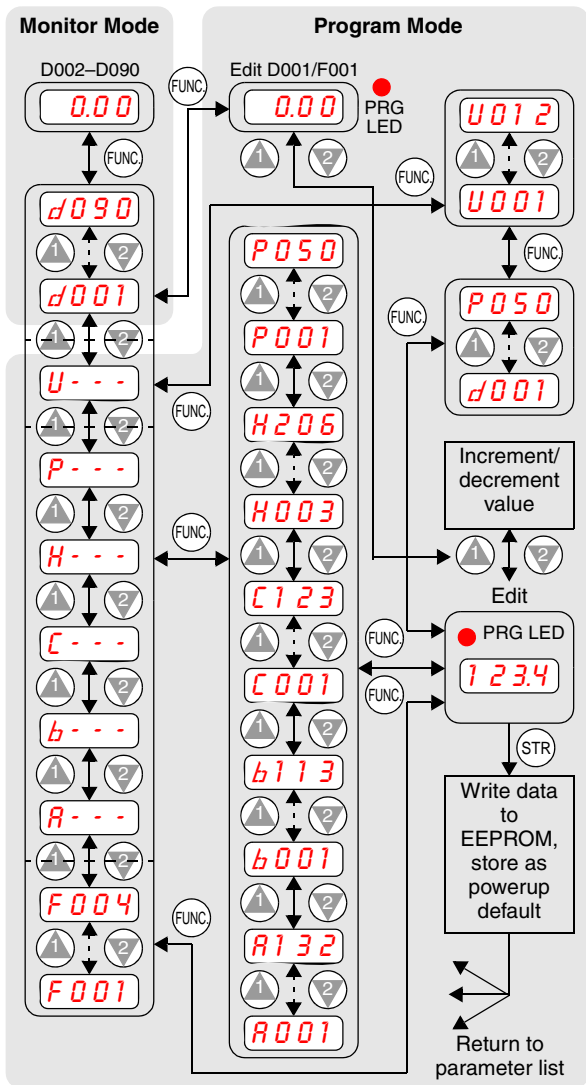

Powerup Test

The Powerup Test procedure uses minimal parameter settings to run the motor. The procedure describes two alternative methods for commanding the inverter: *via the inverter keypad*, or *via the logic terminals*.

- Check power input and motor output wiring (see page 8 diagram).
- If using logic terminals for testing, verify correct wiring on [FW], [CM1], [H], [O], and [L] per the diagram on page 8.
- Reverse [RV] input wiring (defaults to terminal [8]) is optional.

Step	Description	Via Keypad	Via Logic Terminals
1	Set speed command source setting	A001 = 00 (keypad pot.)	A001 = 01, [H–O–L] input
2	Set Run FW command source	A002 = 02 (Run key)	A002 = 01, [FW] input
	Set Run REV command source	—	C008 = 01, [RV] input
3	Set motor base freq.	A003 = 60	
4	Set motor poles (2 / 4 / 6 / 8)	H004 = 4 (default), change only if your motor is different	
5	Set keypad display to monitor freq.	Access D001, press Func key, display will show 0.00	
6	Perform safety check	Disconnect load from motor	
		Turn keypad pot. to MIN position	Ensure voltage on [O]—[L] terminals= 0V
7	Run Forward command	Press Run key	Turn ON the [FW] terminal
8	Increase speed	Rotate keypad pot. CW dir.	Increase voltage at [O]
9	Decrease speed	Rotate keypad pot. CCW dir.	Decrease voltage at [O]
10	Stop motor	Press Stop key	Turn OFF the [FW] terminal
11	Run Reverse command (optional)	—	Turn ON the [RV] terminal
12	Stop motor	—	Turn OFF the [RV] terminal

Error Codes

The L300P series inverters will trip on over-current, over-voltage, and under-voltage to protect the inverter. The motor output turns OFF, allowing the motor to free-run to a stop. Press the Stop/Reset key to reset the inverter and clear the error.





Basic Error Codes

Error Code	Name	Probable Cause(s)
E01	Over current event while at constant speed	<ul style="list-style-type: none"> • Inverter output was short-circuited • Motor shaft is locked • Load is too heavy • A dual-voltage motor is wired incorrectly Note: The L300P will over current trip at nominally 200% of rated current
E02	Over current event during deceleration	
E03	Over current event during acceleration	
E04	Over current event for other conditions	<ul style="list-style-type: none"> • DC braking power(A054) set too high • Current transformer / noise error
E05	Overload protection	<ul style="list-style-type: none"> • Motor overload is detected by the electronic thermal function
E06	Braking resistor overload	<ul style="list-style-type: none"> • Regenerative braking resistor exceeds the usage time or usage ratio
E07	Over voltage protection	<ul style="list-style-type: none"> • DC bus voltage exceeds a threshold, due to regenerative energy from motor
E08	EEPROM error	<ul style="list-style-type: none"> • Built-in EEPROM memory experienced noise, high temperature, etc.
E09	Under-voltage error	<ul style="list-style-type: none"> • DC bus voltage decreased enough to cause a control circuit fault
E10	CT error (current transformer)	<ul style="list-style-type: none"> • High electrical noise near inverter • A fault occurred in the built-in CT
E11	CPU error	<ul style="list-style-type: none"> • Built-in CPU had internal error
E12	External trip	<ul style="list-style-type: none"> • [EXT] input signal detected
E13	USP (Unattended Start Protection)	<ul style="list-style-type: none"> • When (USP) was enabled, an error occurred when power was applied while a Run signal was present
E14	Ground fault	<ul style="list-style-type: none"> • A ground fault was detected between the inverter output and the motor. This feature protects the inverter, and does not protect humans.
E15	Input over-voltage	<ul style="list-style-type: none"> • Input voltage was higher than the specified value, 60 sec. after powerup
E16	Instantaneous power failure	<ul style="list-style-type: none"> • Input power removal > 15ms or > B002... inverter restarts on Run cmd























Error Code	Name	Probable Cause(s)
E21	Inverter thermal trip	• Inverter internal temperature is above the threshold
E23	Gate array error	• An internal inverter error has occurred (CPU / gate array IC)
E24	Phase failure detection	• One of three lines of the 3-phase power is missing
E30	IGBT error	• Instantaneous over-current on any IGBT (output transistor) device
E35	Thermistor	• Thermistor input, [TH] and [CM1], is over the temp. threshold
----	Under-voltage (brownout) with output shutoff	• Low input voltage caused the inverter to turn OFF the motor output and try to restart. If unsuccessful, a trip occurs.
0000	Automatic restart and phase loss	• Inverter is restarting, due to an over-current, over-voltage, under-voltage, or a phase loss event.
E6X	Expansion card #1 error	• An error has occurred in an expansion card or at its connecting terminals. Please refer to the manual for the expansion card for additional details.
E7X	Expansion card #2 error	

Error Status Codes and Error Trip Conditions

The digit to the right of the decimal point in the error code (such as **E01.4**) indicates inverter status at the moment the error occurred. Use the Up and Down arrow keys to scroll through the trip condition parameters.

Status Code	Inverter Status	Status Code	Inverter Status	Trip Conditions
---.0	Reset	---.5	f0 stop	 Error code  Output frequency Motor current  DC bus voltage Cumulative op. time  Cumulative ON time
---.1	Stop	---.6	Starting	
---.2	Deceleration	---.7	DC braking	
---.3	Constant speed	---.8	Overload restriction	
---.4	Acceleration			

Restoring Factory Default Settings

Action	Display	Function/Parameter
Press the  ,  or  keys as needed.	<i>b - - -</i>	“B” Group selected
Press the  key.	<i>b 0 0 1</i>	First “B” Group parameter
Press/hold  until...	<i>b 0 8 5</i>	Country code for initialization selected
Press the  key. If setting is correct, then skip next step.	<i>0 2</i>	00 = Japan 01 = Europe 02 = United States
To change country code, press  or  key to set;  to store.		
Press the  key.	<i>b 0 8 5</i>	Country code for initialization selected
Press the  key.	<i>b 0 8 4</i>	Initialization function selected
Press the  key.	<i>0 0</i>	0 = disable initialization, clear trip history only
Press the  key.	<i>0 1</i>	1 = enable initialization
Press the  key.	<i>b 0 8 4</i>	Initialization now enabled to restore all defaults
Press/hold the  and  keys, then press/hold the  key. Do not release yet.	<i>b 0 8 4</i>	First part of key sequence, the “B” is flashing
Press/hold the  (STOP) key for 3 seconds.	<i>b 0 8 4</i>	Entire “B084” display will begin flashing
Release the  (STOP) key.	<i>0 E U 0 U S A</i>	Default parameter country code shown during initialization process
Release the  ,  , and  keys together.	<i>d 0 0 1</i>	Final part of key sequence, function code for output frequency monitor shown after initialization is complete

Parameter Tables

“D” Group: Monitoring Functions

Parameter Monitoring

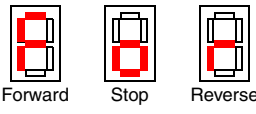
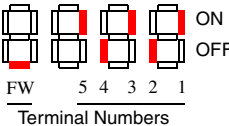
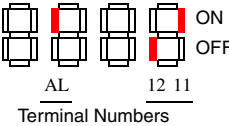
Func. Code	Name / Description	Units
D001	Output frequency monitor	Hz
D002	Output current monitor	A
D003	Rotation direction monitor  Forward Stop Reverse _____ Direction	—
D004	Process variable (PV), PID feedback monitor	%
D005	Intelligent input terminal status  FW 5 4 3 2 1 ON OFF _____ Terminal Numbers	—
D006	Intelligent output terminal status  AL 12 11 ON OFF _____ Terminal Numbers	—
D007	Scaled output frequency monitor (output frequency x B086 scale factor)	User-defined
D012	Torque monitor	%
D013	Output voltage monitor	000.0
D014	Power monitor	kW
D016	Cumulative operation RUN time monitor	hours
D017	Cumulative power-on time monitor	hours

Trip History and Programming Error Monitoring

Func. Code	Name / Description	Units
D080	Trip count – cumulative number of trip events	Events
D081	Trip history – event 1 (newest) — see map below	—
D082	Trip history – event 2 (2nd newest) — see map below	—
D083	Trip history – event 3 (3rd newest) — see map below	—
D084	Trip history – event 4 (4th newest) — see map below	—
D085	Trip history – event 5 (5th newest) — see map below	—
D086	Trip history – event 6 (6th newest) — see map below	—
D090	Programming error monitor, code displayed (see page 35 for an error code listing)	—

Trip History Navigation Map

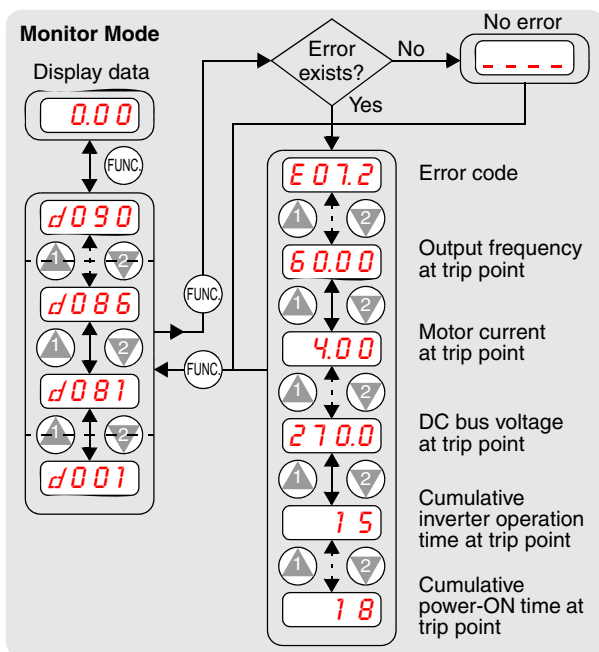

Parameter tables for user-settable functions follow these conventions:

- Some parameters have 2nd and 3rd motor equivalents, indicated by the x2xx and x3xx parameter codes in the left-most column.
- Some parameters specify an option code. Where applicable, the options codes will be in a bulleted list in the Name/Description column.
- The default values apply to all models unless otherwise noted for each parameter... –FE2 (Europe) / –FU2 (U.S.) / –FR (Japan).
- Some parameters cannot be edited during Run Mode, and certain Software Lock settings (B031) can prohibit all edits. If in doubt, place the inverter in Stop Mode or consult the inverter manual for details.

“F” Group: Main Profile Parameters

Func. Code	Name / Description	Default Value –FE2/–FU2/ –FR	Set Value
F001	Output frequency setting	0.00	
F002	Acceleration (1) time setting	30.0 / 60.0 / 30.0	
F202	Acceleration (1) time setting, 2nd motor	30.0 / 60.0 / 30.0	
F003	Deceleration (1) time setting	30.0 / 60.0 / 30.0	
F203	Deceleration (1) time setting, 2nd motor	30.0 / 60.0 / 30.0	
F004	Keypad Run key routing • 00 Forward • 01 Reverse	00	

“A” Group: Standard Functions

Func. Code	Name / Description	Default Value -FE2/-FU2/ -FR	Set Value
A001	Frequency source setting <ul style="list-style-type: none"> • 00 Keypad potentiometer • 01 Control terminal • 02 Function F001 setting • 03 RS485 serial command • 04 Expansion board 1 • 05 Expansion board 2 	01 / 01 / 00	
A002	Run command source setting <ul style="list-style-type: none"> • 01 Input terminal FW or RV (assignable) • 02 Run key on keypad, or digital operator • 03 RS485 serial command • 04 Start/Stop, expansion card #1 • 05 Start/Stop, expansion card #2 	01 / 01 / 02	
A003/ A203	Base frequency setting	50. / 60. / 60.	
A004/ A204	Maximum frequency setting	50. / 60. / 60.	
A005	[AT] selection <ul style="list-style-type: none"> • 00 Select between [O] and [OI] at [AT] • 01 Select between [O] and [O2] at [AT] 	00	
A006	[O2] selection <ul style="list-style-type: none"> • 00 No summing, [O2] and [OI] • 01 Sum of [O2] and [OI], negative sum (reverse speed reference) inhibited • 02 Sum of [O2] and [OI], negative sum (reverse speed reference) allowed • 03 Disable [O2] input 	00	
A011	[O]-[L] input active range start frequency	0.00	
A012	[O]-[L] input active range end frequency	0.00 / 60.0 / 0.00	
A013	[O]-[L] input active range start voltage	0.	
A014	[O]-[L] input active range end voltage	100.	
A015	[O]-[L] input start frequency enable <ul style="list-style-type: none"> • 00 Use A011 start value • 01 Use 0 Hz 	01	
A016	External frequency filter time constant	8.	
A019	Multi-speed operation selection <ul style="list-style-type: none"> • 00 Binary; up to 16-stage speed using 4 intelligent terminals • 01 Single-bit; up to 8-stage speed using 7 intelligent terminals 	00	

Func. Code	Name / Description	Default Value -FE2/-FU2/ -FR	Set Value
A020/ A220	Multi-speed frequency setting	0.00	
A021 to A035	Multi-speed frequency settings (for both motors)	0.00	
A038	Jog frequency setting	1.00	
A039	Jog stop mode <ul style="list-style-type: none"> • 00 Free-run stop, jogging disabled during motor run • 01 Controlled deceleration, jogging disabled during motor run • 02 DC braking to stop, jogging disabled during motor run • 03 Free-run stop, jogging always enabled • 04 Controlled deceleration, jogging always enabled • 05 DC braking to stop, jogging always enabled 	00	
A041/ A241	Torque boost method selection <ul style="list-style-type: none"> • 00 Manual torque boost • 01 Automatic torque boost 	00	
A042/ A242	Manual torque boost value	1.0	
A043/ A243	Manual torque boost frequency adjustment	5.0	
A044/ A244	V/f characteristic curve selection <ul style="list-style-type: none"> • 00 V/f constant torque • 01 V/f variable torque • 02 V/f free-setting curve 	00 / 01 / 00	
A045	V/f gain setting	100.	
A051	DC braking enable <ul style="list-style-type: none"> • 00 Disable • 01 Enable 	00	
A052	DC braking frequency setting	0.50	
A053	DC braking wait time	0.0	
A054	DC braking force during deceleration	0.	
A055	DC braking time for deceleration	0.0	
A056	DC braking / edge or level detection for [DB] input	01	
A057	DC braking force for starting	0.	
A058	DC braking time for starting	0.0	
A059	DC braking carrier frequency setting	3.0	

Func. Code	Name / Description	Default Value -FE2/-FU2/ -FR	Set Value
A061/ A261	Frequency upper limit setting	0.00	
A062/ A262	Frequency lower limit setting	0.00	
A063 A065 A067	Jump (center) frequency setting	0.00	
A064 A066 A068	Jump (hysteresis) frequency width setting	0.50	
A069	Acceleration pause frequency setting	0.00	
A070	Acceleration pause time setting	0.0	
A071	PID Enable • 00 PID operation OFF • 01 PID operation ON	00	
A072	PID proportional gain	1.0	
A073	PID integral time constant	1.0	
A074	PID derivative time constant	0.0	
A075	PV scale conversion	1.00	
A076	PV source setting: • 00 [OI] terminal (current input) • 01 [O] terminal (voltage input)	00	
A081	AVR function select • 00 AVR enabled • 01 AVR disabled • 02 AVR enabled except during decel	00 / 00 / 02	
A082	AVR voltage select	230 230 200 400 460 400	
A085	Operation mode selection • 00 Normal operation • 01 Energy-saver operation	00	
A086	Energy saving mode tuning	50.0	
A092/ A292	Acceleration (2) time setting	15.0	
A093/ A293	Deceleration (2) time setting	15.0	
A094/ A294	Select method to switch to Acc2/Dec2 profile • 00 2CH input from terminal • 01 transition frequency	00	

Func. Code	Name / Description	Default Value -FE2/-FU2/ -FR	Set Value
A095/ A295	Acc1 to Acc2 frequency transition point	0.0	
A096/ A296	Dec1 to Dec2 frequency transition point	0.0	
A097	Acceleration curve selection <ul style="list-style-type: none"> • 00 Linear • 01 S-curve • 02 U-shape • 03 Reverse U-shape 	00	
A098	Deceleration curve selection <ul style="list-style-type: none"> • 00 Linear • 01 S-curve • 02 U-shape • 03 Reverse U-shape 	00	
A101	[OI]-[L] input active range start frequency	0.00	
A102	[OI]-[L] input active range end frequency	0.00 / 60.00 / 0.00	
A103	[OI]-[L] input active range start current	20.	
A104	[OI]-[L] input active range end current	100.	
A105	[OI]-[L] input start frequency enable <ul style="list-style-type: none"> • 00 Use A101 start value • 01 Use 0Hz 	01	
A111	[O2]-[L] input active range start frequency	0.00	
A112	[O2]-[L] input active range end frequency	0.00	
A113	[O2]-[L] input active range start voltage	-100.	
A114	[O2]-[L] input active range end voltage	100.	
A131	Acceleration curve constants setting	02	
A132	Deceleration curve constants setting	02	

“B” Group: Fine-tuning Functions

Func. Code	Name / Description	Default Value -FE2/-FU2/ -FR	Set Value
B001	Selection of automatic restart mode <ul style="list-style-type: none"> • 00 Alarm output after trip, automatic restart disabled • 01 Restart at 0Hz • 02 Resume operation after frequency matching • 03 Resume previous freq. after freq. matching, then decelerate to stop and display trip info 	00	
B002	Allowable under-voltage power failure time	1.0	
B003	Retry wait time before motor restart	1.0	
B004	Instantaneous power failure / under-voltage trip alarm enable <ul style="list-style-type: none"> • 00 Disable • 01 Enable • 02 Disable during stop and ramp to stop 	00	
B005	Number of restarts on power failure / under-voltage trip events <ul style="list-style-type: none"> • 00 Restart 16 times • 01 Always restart 	00	
B006	Phase loss detection enable <ul style="list-style-type: none"> • 00 Disable – no trip on phase loss • 01 Enable – trip on phase loss 	0.00	
B007	Restart frequency threshold	1.0	
B012/ B212	Level of electronic thermal setting	Rated current of each inverter	
B013/ B213	Electronic thermal characteristic <ul style="list-style-type: none"> • 00 Reduced torque • 01 Const. torque • 02 V/f free-setting 	01 / 00 / 00	
B015	Free setting, electronic thermal freq. (1)	0.	
B016	Free setting, electronic thermal current (1)	0.0	
B017	Free setting, electronic thermal freq. (2)	0.	
B018	Free setting, electronic thermal current (2)	0.0	
B019	Free setting, electronic thermal freq. (3)	0.	
B020	Free setting, electronic thermal current (3)	0.0	
B021	Overload restriction operation mode <ul style="list-style-type: none"> • 00 Disabled • 01 Enabled for accel and constant speed • 02 Enabled for constant speed only 	01	

Func. Code	Name / Description	Default Value -FE2/-FU2/ -FR	Set Value
B022	Overload restriction setting	Rated current x 1.20 / 1.10 / 1.20	
B023	Deceleration rate at overload restriction	1.00 / 15.00 / 1.00	
B024	Overload restriction operation mode (2) • 00 Disabled • 01 Enabled for accel and constant speed • 02 Enabled for constant speed only	01	
B025	Overload restriction setting (2)	Rated current x 1.20	
B026	Deceleration rate at overload restriction (2)	1.00	
B031	Software lock mode selection • 00 Low-level access, [SFT] blocks edits • 01 Low-level access, [SFT] blocks edits (except F001 and Multi-speed parameters) • 02 No access to edits • 03 No access to edits except F001 and Multi-speed parameters • 10 High-level access, including B031	01	
B034	Run/power on warning time	0.	
B035	Rotational direction restriction • 00 Enable for both directions • 01 Enable for forward only • 02 Enable for reverse only	00	
B036	Reduced voltage start selection • 00 Short • 01, 02, 03, 04, 05 (middle) • 06 Long	06	
B037	Function code display restriction • 00 Display all • 01 Display only utilized functions • 02 Display user-selected functions only (configure with U01 to U12)	00	
B080	[AM] terminal analog meter adjustment	180	
B081	[FM] terminal analog meter adjustment	60	
B082	Start frequency adjustment	0.50	
B083	Carrier frequency setting	3.0	

Func. Code	Name / Description	Default Value -FE2/-FU2/ -FR	Set Value
B084	Initialization mode (parameters or trip history) <ul style="list-style-type: none"> • 00 Trip history clear • 01 Parameter initialization • 02 Trip history clear and parameter initialization 	00	
B085	Country code for initialization <ul style="list-style-type: none"> • 00 Japan version • 01 Europe version • 02 US version • 03 (reserved) 	01 / 02 / 00	
B086	Frequency scaling conversion factor	1.0	
B087	STOP key enable <ul style="list-style-type: none"> • 00 Enable • 01 Disable 	00	
B088	Restart mode after FRS <ul style="list-style-type: none"> • 00 Restart from 0Hz • 01 Restart from frequency detected from actual speed of motor 	00	
B090	Dynamic braking usage ratio	00	
B091	Stop mode selection	00	
B092	Cooling fan control <ul style="list-style-type: none"> • 00 Fan always ON • 01 Fan ON during Run, OFF during Stop 	00	
B095	Dynamic braking control <ul style="list-style-type: none"> • 00 Disable • 01 Enable during RUN only • 02 Enable always 	00	
B096	Dynamic braking activation level	360/ 720	
B098	Thermistor for thermal protection control <ul style="list-style-type: none"> • 00 Disable • 01 Enable – PTC thermistor • 02 Enable – NTC thermistor 	00	
B099	Thermal protection level setting	3000	
B100	Free-setting V/f frequency (1)	0.	
B101	Free-setting V/f voltage (1)	0.0	
B102	Free-setting V/f frequency (2)	0.	
B103	Free-setting V/f voltage (2)	0.0	
B104	Free-setting V/f frequency (3)	0.	
B105	Free-setting V/f voltage (3)	0.0	
B106	Free-setting V/f frequency (4)	0.	
B107	Free-setting V/f voltage (4)	0.0	

Func. Code	Name / Description	Default Value -FE2/-FU2/ -FR	Set Value
B108	Free-setting V/f frequency (5)	0.	
B109	Free-setting V/f voltage (5)	0.0	
B110	Free-setting V/f frequency (6)	0.	
B111	Free-setting V/f voltage (6)	0.0	
B112	Free-setting V/f frequency (7)	0.	
B113	Free-setting V/f voltage (7)	0.0	

“C” Group: Intelligent Terminal Functions

Func. Code	Name / Description	Default Value -FE2/-FU2/ -FR	Set Value
C001	Terminal [1] function	33 option codes available (34 codes for -xFE2/-xFU2 models) (see page 31)	18
C002	Terminal [2] function		16
C003	Terminal [3] function		03 / 13 / 03
C004	Terminal [4] function		02
C005	Terminal [5] function		01
C011	Terminal [1] active state	<ul style="list-style-type: none"> • 00 Normally open [NO] • 01 Normally closed [NC] 	00
C012	Terminal [2] active state		00
C013	Terminal [3] active state		00 / 01 / 00
C014	Terminal [4] active state		00
C015	Terminal [5] active state		00
C019	Terminal [FW] active state		00
C021	Terminal [11] function	12 option codes available (13 codes for -xFE2/-xFU2 models) (see page 32)	01
C022	Terminal [12] function		00
C026	Alarm relay terminal function		05

Func. Code	Name / Description		Default Value -FE2/-FU2/ -FR	Set Value
C027	[FM] signal selection	7 option codes available (see page 34)	00	
C028	[AM] signal selection		00	
C029	[AMI] signal selection		00	
C031	Terminal [11] active state	• 00 Normally open (NO) • 01 Normally closed (NC)	00	
C032	Terminal [12] active state		00	
C036	Alarm relay terminal active state		01	
C040	Overload signal output mode • 00 During accel/decel • 01 During constant speed		01	
C041	Overload level setting		Rated current of each inverter	
C042	Frequency arrival setting for accel		0.00	
C043	Arrival frequency setting for decel		0.00	
C044	PID deviation level setting		3.0	
C061	Electronic thermal warning level		80.	
C070	Data command method • 02 Digital operator • 03 RS485 • 04 Expansion card #1 • 05 Expansion card #2		02	
C071	Communication speed selection • 02 (Test) • 03 2400bps • 04 4800bps • 05 9600bps • 06 19200bps		04	
C072	Node allocation		1.	
C073	Communication data length selection • 07 7-bit data • 08 8-bit data		7	
C074	Communication parity selection • 00 No parity • 01 Even parity • 02 Odd parity		00	
C075	Communication stop bit selection • 01 1 stop bit • 02 2 stop bits		1	
C078	Communication wait time		0.	
C081	[O] input span calibration		Factory calibrated	
C082	[OI] input span calibration			
C083	[O2] input span calibration			

Func. Code	Name / Description	Default Value -FE2/-FU2/ -FR	Set Value
C085	Thermistor input tuning	105.0	
C086	[AM] terminal offset tuning	0.0	
C087	[AMI] terminal meter tuning	80.	
C088	[AMI] terminal offset tuning	Factory calibrated	
C121	[O] input zero calibration		
C122	[OI] input zero calibration		
C123	[O2] input zero calibration		
C091	Debug mode enable • 00 Display • 01 No display	00	
C101	Up/Down memory mode selection • 00 Clear last frequency (return to F001) • 01 Keep last freq. adjusted by UP/DWN	00	
C102	Reset mode selection • 00 Cancel trip state at input signal ON transition, Stops inverter if in Run Mode • 01 Cancel trip state at signal OFF transition, Stops inverter if in Run Mode • 02 Cancel trip state at input signal ON transition, no effect if in Run Mode	00	
C103	Restart mode after reset • 00 Restart at 0 Hz • 01 Resume after frequency matching	00	

“H” Group: Motor Constants Functions

Func. Code	Name / Description	Default Value -FE2/-FU2/ -FR	Set Value
H003/ H203	Motor capacity	Factory set	
H004/ H204	Motor poles setting • 2 poles • 4 poles • 6 poles • 8 poles	4	
H006/ H206	Motor stabilization constant	100.	

“P” Group: Expansion Card Functions

Func. Code	Name / Description	Default Value -FE2/-FU2/ -FR	Set Value
P001	Operation mode on expansion card #1 error <ul style="list-style-type: none"> • 00 Trip (stop motor) • 01 Continuous operation 	00	
P002	Operation mode on expansion card #2 error <ul style="list-style-type: none"> • 00 Trip (stop motor) • 01 Continuous operation 	00	
P044	DeviceNet comm watchdog timer	1.00	
P045	Inverter action on DeviceNet comm error <ul style="list-style-type: none"> • 00 Trip • 01 Decelerate and trip • 02 Hold last speed • 03 Free run stop • 04 Decelerate and stop 	01	
P046	DeviceNet polled I/O: Output instance number	21	
P047	DeviceNet polled I/O: Input instance number	71	
P048	Inverter action on DeviceNet idle mode <ul style="list-style-type: none"> • 00 Trip • 01 Decelerate and trip • 02 Hold last speed • 03 Free run stop • 04 Decelerate and stop 	01	
P049	DeviceNet motor poles setting for RPM	0	
P050	<ul style="list-style-type: none"> • Output frequency on analog reference signal loss (-xFE2/-xFU2 models only) • 00 Output freq. forced to 0 Hz; 500ms wait to recover • 01 Output freq. forced to 0 Hz; no wait to recover • 02 Output freq. forced to max. freq. A004 • 03 Output freq. forced to A020/A220 	00 / 00 / —	

“U” Group: User-selectable Menu Functions

Func. Code	Name / Description	Default Value	Set Value
U001	User-selected function, D001 to P049	no	
U002	User-selected function, D001 to P049	no	
U003	User-selected function, D001 to P049	no	
U004	User-selected function, D001 to P049	no	
U005	User-selected function, D001 to P049	no	
U006	User-selected function, D001 to P049	no	
U007	User-selected function, D001 to P049	no	
U008	User-selected function, D001 to P049	no	
U009	User-selected function, D001 to P049	no	
U010	User-selected function, D001 to P049	no	
U011	User-selected function, D001 to P049	no	
U012	User-selected function, D001 to P049	no	

Intelligent Input Terminal Listing

Symbol	Code	Input Terminal Name
RV	01	Reverse Run/Stop
CF1	02	Multi-speed select, Bit 0 (LSB)
CF2	03	Multi-speed select, Bit 1
CF3	04	Multi-speed select, Bit 2
CF4	05	Multi-speed select, Bit 3 (LSB)
JG	06	Jogging
DB	07	External DC injection braking signal
SET	08	Set (select) second motor data
2CH	09	2-stage accel and decel
FRS	11	Free-run stop
EXT	12	External trip
USP	13	Unattended start protection
CS	14	Commercial power source
SFT	15	Software lock
AT	16	Analog input voltage/current sel.
RS	18	Reset inverter
STA	20	Start (3-wire interface)
STP	21	Stop (3-wire interface)
F/R	22	FW, RV (3-wire interface)
PID	23	PID ON/OFF
PIDC	24	PID Reset
UP	27	Remote control Up func.
DWN	28	Remote control Down func.
UDC	29	Remote control data clearing
OPE	31	Operator control
SF1–SF7	32–38	Multi-speed bits 1 to 7
OLR	39	Overload restriction
ROK	49	Run Enable for FW/RV (–xFU2 and –xFE2 models only)

Intelligent Output Terminal Listing

Symbol	Code	Input Terminal Name
RUN	00	Run signal
FA1	01	Freq. arrival type 1 – constant speed
FA2	02	Freq. arrival type 2 – over-frequency
OL	03	Overload advance notice signal
OD	04	Output deviation for PID control
AL	05	Alarm signal
FA3	06	Freq. arrival type 3 – at frequency
IP	08	Instantaneous power failure signal
UV	09	Under-voltage signal
RNT	11	Run time over
ONT	12	Power-ON time over
THM	13	Thermal alarm signal
RMD	27	Run command source monitor (-xFU2 and -xFE2 models only)

Analog Input Configuration

The following tables show the parameter settings required for various analog input signal types.

A006	A005	[AT]	External Frequency Command Input	Trim Frequency Command Input	Reverse available (bipolar input)
00	00	OFF	[O] — [L]	✗	✗
		ON	[OI] — [L]	✗	✗
	01	OFF	[O] — [L]	✗	✗
		ON	[O2] — [L]	✗	✓
01	00	OFF	[O] — [L]	[O2] — [L]	✗
		ON	[OI] — [L]	[O2] — [L]	✗
	01	OFF	[O] — [L]	[O2] — [L]	✗
		ON	[O2] — [L]	✗	✓
02	00	OFF	[O] — [L]	[O2] — [L]	✓
		ON	[OI] — [L]	[O2] — [L]	✓
	01	OFF	[O] — [L]	[O2] — [L]	✓
		ON	[O2] — [L]	✗	✓

The table below applies when the [AT] input function is not assigned to *any* intelligent input terminal. The A005 setting, normally used in conjunction with an [AT] input, is ignored.

A006	A005	[AT]	External Frequency Command Input	Trim Frequency Command Input	Reverse available (bipolar input)
00	—	(not assigned to any input terminal)	[O2] — [L]	✗	✓
01	—		Summation of [O] — [L] and [OI] — [L]	[O2] — [L]	✗
02	—		Summation of [O] — [L] and [OI] — [L]	[O2] — [L]	✓

Analog Output Function Listing

The following table shows all seven functions available for assignment to the three analog output terminals:

- Terminal [FM], option set by C027
- Terminal [AM], option set by C028
- Terminal [AMI], option set by C029

Option Code	Function Name	Description	Corresponding Signal Range
00	Output frequency	Actual motor speed, represented by PWM signal	0 to max. frequency in Hz
01	Output current	Motor current (% of maximum rated output current), represented by PWM signal	0 to 200%
03	Digital output frequency	Output frequency (available only at FM output)	0 to max. frequency in Hz
04	Output voltage	Rated output voltage to motor	0 to 100%
05	Input power	Rated input power	0 to 200%
06	Electronic thermal overload	Percentage of electronic overload attained	0 to 100%
07	LAD frequency	Internal ramp generator frequency	0 to max. frequency in Hz

Programming Error Codes

The L300P inverter operator keypad displays a special code (begins with the **H** character) to indicate a programming error. Programming errors exist when one parameter conflicts with the meaningful range permitted by related parameter(s). Note that particular real-time frequency (speed) input levels can cause a conflict in some situations. After a conflict exists, the error code will appear on the display, or you can view it later with D090 in Monitor Mode. Also, the PGM LED on the display will flash ON/OFF when programming. These indications are automatically cleared when the parameter is corrected to the allowed range.

Prg Error Code	Function code of parameter out of bounds	Boundary defined by...	
		<, >	Base parameter
H001H201	A061 / A261	>	A004 / A204
H002H202	A062 / A262	>	
H004H204	A003 / A203	>	
H005H205	F001, A020 / A220	>	
H006H206	A021 to A035	>	
H012H212	A062 / A262	>	A061 / A261
H015H215	F001, A020 / A220	>	
H016H216	A021 to A035	>	
H021H221	A061 / A261	<	A062 / A262
H025H225	F001, A020 / A220	<	
H031H231	A061 / A261	<	B082
H032H232	A062 / A262	<	
H035H235	F001, A202 / A220	<	
H036	A021 to A035	<	
H037	A038	<	

Prg Error Code	Function code of parameter out of bounds	Boundary defined by...	
		<, >	Base parameter
8085 8285	F001, A020 / A220	>f-x, <f+x	A063 ± A064 A065 ± A066 A067 ± A068 (see note below)
8086	A021 to A035	>f-x, <f+x	
8091 8291	A061 / A261	>	B112
8092 8292	A062 / A262	>	
8095 8295	F001, A020 / A220	>	
8096	A021 to A035	>	
8110	B100, B102, B104, B106, B108, B110	>	
	B102, B104, B106, B108, B110	<	B100
	B100	>	B102
	B104, B106, B108, B110	<	
	B100, B102	>	B104
	B106, B108, B110	<	
	B100, B102, B104	>	B106
	B108, B110	<	
	B100, B102, B104, B106	>	B108
	B110	<	
	B100, B102, B104, B106, B108	>	B110
8120	B017, B019	<	B015
	B015	>	B017
	B019	<	
	B015, B017	>	B019

 **Note:** Set frequency (speed) values are not permitted to be inside the jump frequency ranges, if defined. When a frequency reference value from a real-time source (such as keypad potentiometer or analog input) are inside a jump frequency range, the actual speed is automatically forced to equal the lowest point of the jump range.