

HITACHI CP-X809 Series

CP-X809 UNIT:mm[Inches]

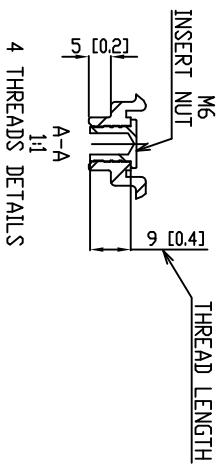

Screen size(4:3 Diagonal) Inch	Image height(k) Inch(cm)	Throw distance (α)	
		Min Inch(cm)	Max Inch(cm)
30"	18"(46)	35"(0.9)	42"(1.1)
40"	24"(61)	47"(1.2)	57"(1.4)
50"	30"(76)	59"(1.5)	71"(1.8)
60"	36"(91)	71"(1.8)	86"(2.2)
70"	42"(107)	84"(2.1)	100"(2.5)
80"	48"(122)	96"(2.4)	115"(2.9)
100"	80"(152)	120"(3.0)	144"(3.7)
120"	72"(183)	144"(3.7)	173"(4.4)
150"	90"(229)	181"(4.6)	217"(5.5)
200"	120"(305)	242"(6.1)	290"(7.4)
250"	150"(381)	302"(7.7)	363"(9.2)
300"	180"(457)	363"(9.2)	436"(11.1)
350"	210"(533)	424"(10.8)	509"(12.9)

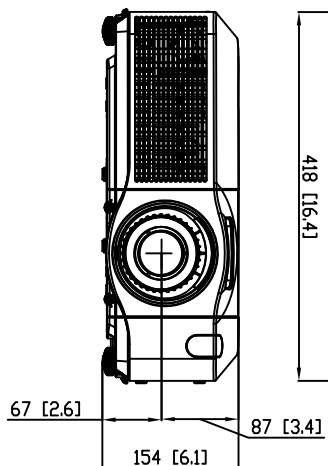
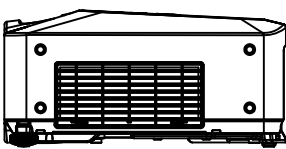
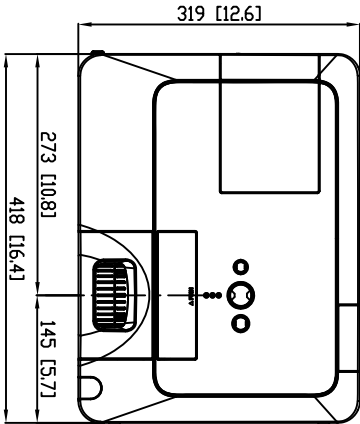
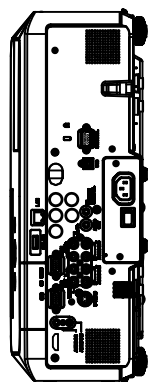
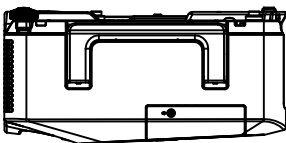
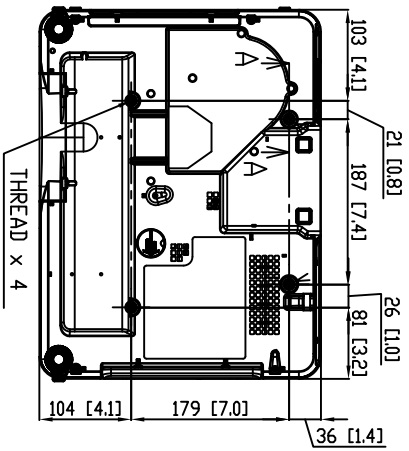